

# NCP5104, NCV5104

## Single Input High Voltage High and Low-Side MOSFET or IGBT Drivers

The NCP5104 is a High Voltage Power gate Driver providing two outputs for direct drive of 2 N-channel power MOSFETs or IGBTs arranged in a half-bridge configuration. It uses the bootstrap technique to insure a proper drive of the High-side power switch.

### Features

- High Voltage Range: up to 600 V
- $dV/dt$  Immunity  $\pm 50$  V/nsec
- Gate Drive Supply Range from 10 V to 20 V
- High and Low Drive Outputs
- Output Source / Sink Current Capability 250 mA / 500 mA
- 3.3 V and 5 V Input Logic Compatible
- Up to  $V_{CC}$  Swing on Input Pins
- Extended Allowable Negative Bridge Pin Voltage Swing to  $-10$  V for Signal Propagation
- Matched Propagation Delays between Both Channels
- 1 Input with Internal Fixed Dead Time (520 ns)
- Under  $V_{CC}$  LockOut (UVLO) for Both Channels
- Pin to Pin Compatible with Industry Standards
- NCV Prefix for Automotive and Other Applications Requiring Unique Site and Control Change Requirements; AEC-Q100 Qualified and PPAP Capable
- These Devices are Pb-Free, Halogen Free/BFR Free and are RoHS Compliant

### Typical Applications

- Half-Bridge Power Converters

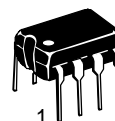


ON Semiconductor®

[www.onsemi.com](http://www.onsemi.com)

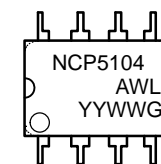
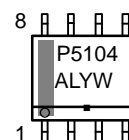


1  
SOIC-8  
D SUFFIX  
CASE 751



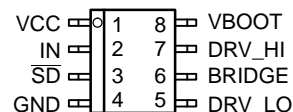
1  
PDIP-8  
P SUFFIX  
CASE 626

### MARKING DIAGRAMS



NCP5104 = Specific Device Code  
 A = Assembly Location  
 L or WL = Wafer Lot  
 Y or YY = Year  
 W or WW = Work Week  
 G or ■ = Pb-Free Package

### PINOUT INFORMATION



8 Pin Package

### ORDERING INFORMATION

Device	Package	Shipping†
NCP5104PG	PDIP-8 (Pb-Free)	50 Units / Rail
NCP5104DR2G	SOIC-8 (Pb-Free)	2500 / Tape & Reel
NCV5104DR2G	SOIC-8 (Pb-Free)	2500 / Tape & Reel

†For information on tape and reel specifications, including part orientation and tape sizes, please refer to our Tape and Reel Packaging Specification Brochure, BRD8011/D.

# NCP5104, NCV5104

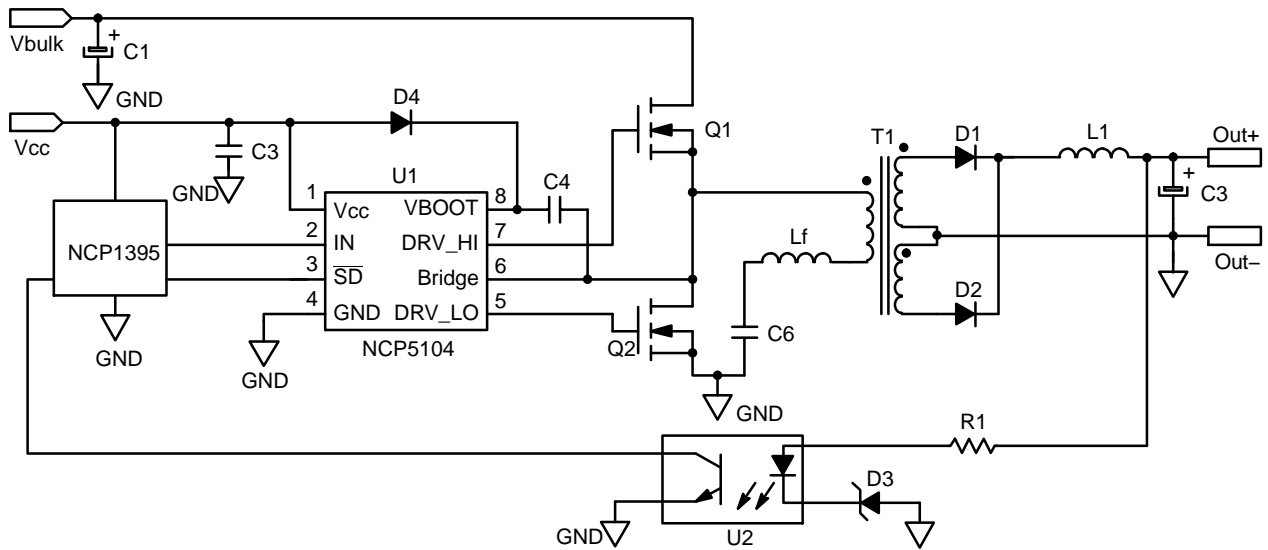


Figure 1. Typical Application Resonant Converter (LLC type)

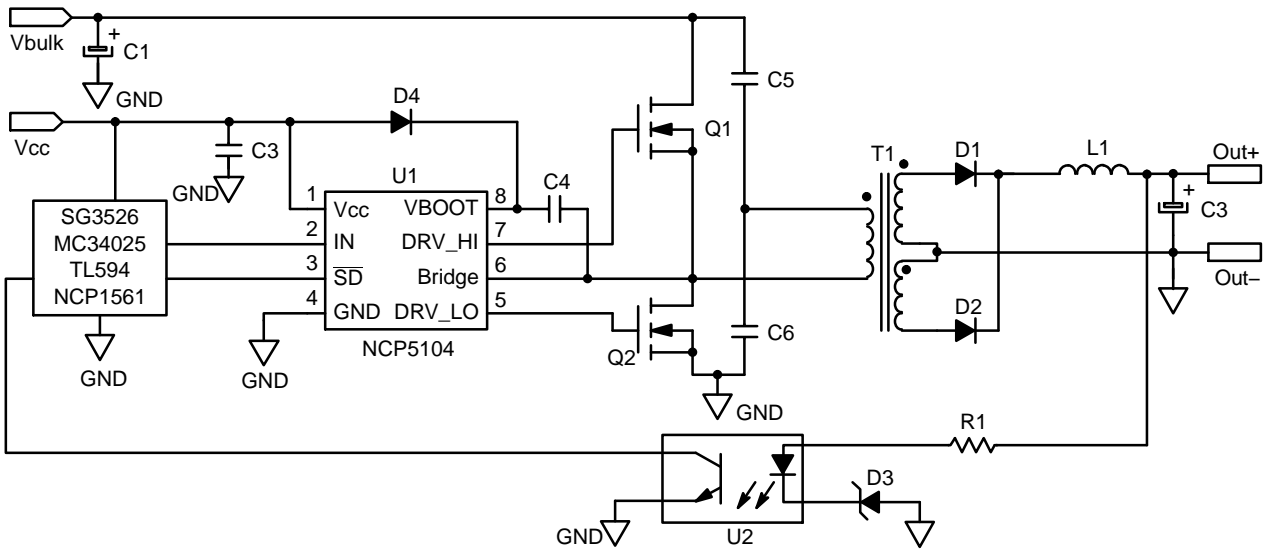


Figure 2. Typical Application Half Bridge Converter

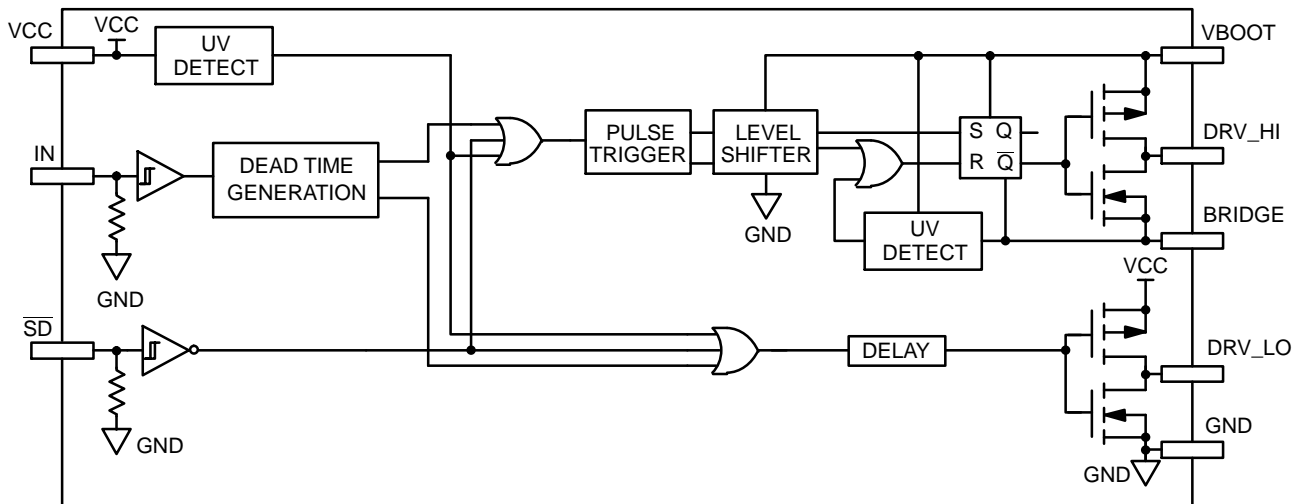


Figure 3. Detailed Block Diagram

# NCP5104, NCV5104

## PIN DESCRIPTION

Pin Name	Description
V <sub>CC</sub>	Low Side and Main Power Supply
IN	Logic Input
$\overline{SD}$	Logic Input for Shutdown
GND	Ground
DRV_LO	Low Side Gate Drive Output
V <sub>BOOT</sub>	Bootstrap Power Supply
DRV_HI	High Side Gate Drive Output
BRIDGE	Bootstrap Return or High Side Floating Supply Return

## MAXIMUM RATINGS

Rating	Symbol	Value	Unit
V <sub>CC</sub>	Main power supply voltage	-0.3 to 20	V
V <sub>CC_transient</sub>	Main transient power supply voltage: I <sub>V<sub>CC_max</sub></sub> = 5 mA during 10 ms	23	V
V <sub>BOOT</sub>	VHV: High Voltage BOOT Pin	-1 to 620	V
V <sub>BRIDGE</sub>	VHV: High Voltage BRIDGE pin	-1 to 600	V
V <sub>BRIDGE</sub>	Allowable Negative Bridge Pin Voltage for IN_LO Signal Propagation to DRV_LO (see characterization curves for detailed results)	-10	V
V <sub>BOOT-V<sub>BRIDGE</sub></sub>	VHV: Floating supply voltage	-0.3 to 20	V
V <sub>DRV_HI</sub>	VHV: High side output voltage	V <sub>BRIDGE</sub> - 0.3 to V <sub>BOOT</sub> + 0.3	V
V <sub>DRV_LO</sub>	Low side output voltage	-0.3 to V <sub>CC</sub> + 0.3	V
dV <sub>BRIDGE</sub> /dt	Allowable output slew rate	50	V/ns
V <sub>IN</sub> , V <sub>SD</sub>	Inputs IN & SD	-1.0 to V <sub>CC</sub> + 0.3	V
	ESD Capability: - HBM model (all pins except pins 6-7-8 in 8) - Machine model (all pins except pins 6-7-8)	2 200	kV V
	Latch up capability per JEDEC JESD78		
R <sub>θJA</sub>	Power dissipation and Thermal characteristics PDIP-8: Thermal Resistance, Junction-to-Air SO-8: Thermal Resistance, Junction-to-Air	100 178	°C/W
T <sub>ST</sub>	Storage Temperature Range	-55 to +150	°C
T <sub>J_max</sub>	Maximum Operating Junction Temperature	+150	°C

Stresses exceeding those listed in the Maximum Ratings table may damage the device. If any of these limits are exceeded, device functionality should not be assumed, damage may occur and reliability may be affected.

# NCP5104, NCV5104

**ELECTRICAL CHARACTERISTIC** ( $V_{CC} = V_{boot} = 15\text{ V}$ ,  $V_{GND} = V_{bridge}$ ,  $-40^{\circ}\text{C} < T_J < 125^{\circ}\text{C}$ , Outputs loaded with 1 nF)

Rating	Symbol	$T_J -40^{\circ}\text{C to } 125^{\circ}\text{C}$			Units
		Min	Typ	Max	

## OUTPUT SECTION

Output high short circuit pulsed current $V_{DRV} = 0\text{ V}$ , $PW \leq 10\ \mu\text{s}$ (Note 1)	$I_{DRVsource}$	–	250	–	mA
Output low short circuit pulsed current $V_{DRV} = V_{CC}$ , $PW \leq 10\ \mu\text{s}$ (Note 1)	$I_{DRVsink}$	–	500	–	mA
Output resistor (Typical value @ $25^{\circ}\text{C}$ ) Source	$R_{OH}$	–	30	60	$\Omega$
Output resistor (Typical value @ $25^{\circ}\text{C}$ ) Sink	$R_{OL}$	–	10	20	$\Omega$
High level output voltage, $V_{BIAS} - V_{DRV\_XX}$ @ $I_{DRV\_XX} = 20\text{ mA}$	$V_{DRV\_H}$	–	0.7	1.6	V
Low level output voltage $V_{DRV\_XX}$ @ $I_{DRV\_XX} = 20\text{ mA}$	$V_{DRV\_L}$	–	0.2	0.6	V

## DYNAMIC OUTPUT SECTION

Turn-on propagation delay ( $V_{bridge} = 0\text{ V}$ ) (Note 2)	$t_{ON}$	–	620	800	ns
Turn-off propagation delay ( $V_{bridge} = 0\text{ V}$ or $50\text{ V}$ ) (Note 3)	$t_{OFF}$	–	100	170	ns
Shutdown propagation delay, when Shutdown is enabled	$t_{sd\_en}$	–	100	170	ns
Shutdown propagation delay, when Shutdown is disabled	$t_{sd\_dis}$	–	620	800	ns
Output voltage rise time (from 10% to 90% @ $V_{CC} = 15\text{ V}$ ) with 1 nF load	$t_r$	–	85	160	ns
Output voltage fall time (from 90% to 10% @ $V_{CC} = 15\text{ V}$ ) with 1 nF load	$t_f$	–	35	75	ns
Propagation delay matching between the High side and the Low side @ $25^{\circ}\text{C}$ (Note 4)	$\Delta t$	–	10	45	ns
Internal fixed dead time (Note 5)	DT	400	520	650	ns

## INPUT SECTION

Low level input voltage threshold	$V_{IN}$	–	–	0.8	V
Input pull-down resistor ( $V_{IN} < 0.5\text{ V}$ )	$R_{IN}$	–	200	–	k $\Omega$
High level input voltage threshold	$V_{IN}$	2.3	–	–	V
Logic “1” input bias current @ $V_{IN} = 5\text{ V}$ @ $25^{\circ}\text{C}$	$I_{IN+}$	–	5	25	$\mu\text{A}$
Logic “0” input bias current @ $V_{IN} = 0\text{ V}$ @ $25^{\circ}\text{C}$	$I_{IN-}$	–	–	2.0	$\mu\text{A}$

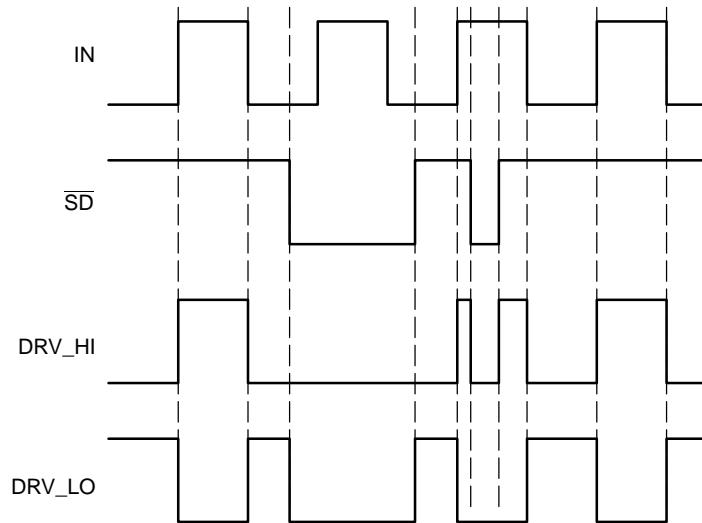
## SUPPLY SECTION

Vcc UV Start-up voltage threshold	$V_{cc\_stup}$	8.0	8.9	9.8	V
Vcc UV Shut-down voltage threshold	$V_{cc\_shtdwn}$	7.3	8.2	9.0	V
Hysteresis on Vcc	$V_{cc\_hyst}$	0.3	0.7	–	V
Vboot Start-up voltage threshold reference to bridge pin ( $V_{boot\_stup} = V_{boot} - V_{bridge}$ )	$V_{boot\_stup}$	8.0	8.9	9.8	V
Vboot UV Shut-down voltage threshold	$V_{boot\_shtdwn}$	7.3	8.2	9.0	V
Hysteresis on Vboot	$V_{boot\_shtdwn}$	0.3	0.7	–	V
Leakage current on high voltage pins to GND ( $V_{BOOT} = V_{BRIDGE} = DRV\_HI = 600\text{ V}$ )	$I_{HV\_LEAK}$	–	5	40	$\mu\text{A}$
Consumption in active mode ( $V_{cc} = V_{boot}$ , $f_{sw} = 100\text{ kHz}$ and 1 nF load on both driver outputs)	ICC1	–	4	5	mA
Consumption in inhibition mode ( $V_{cc} = V_{boot}$ )	ICC2	–	250	400	$\mu\text{A}$
Vcc current consumption in inhibition mode	ICC3	–	200	–	$\mu\text{A}$
Vboot current consumption in inhibition mode	ICC4	–	50	–	$\mu\text{A}$

Product parametric performance is indicated in the Electrical Characteristics for the listed test conditions, unless otherwise noted. Product performance may not be indicated by the Electrical Characteristics if operated under different test conditions.

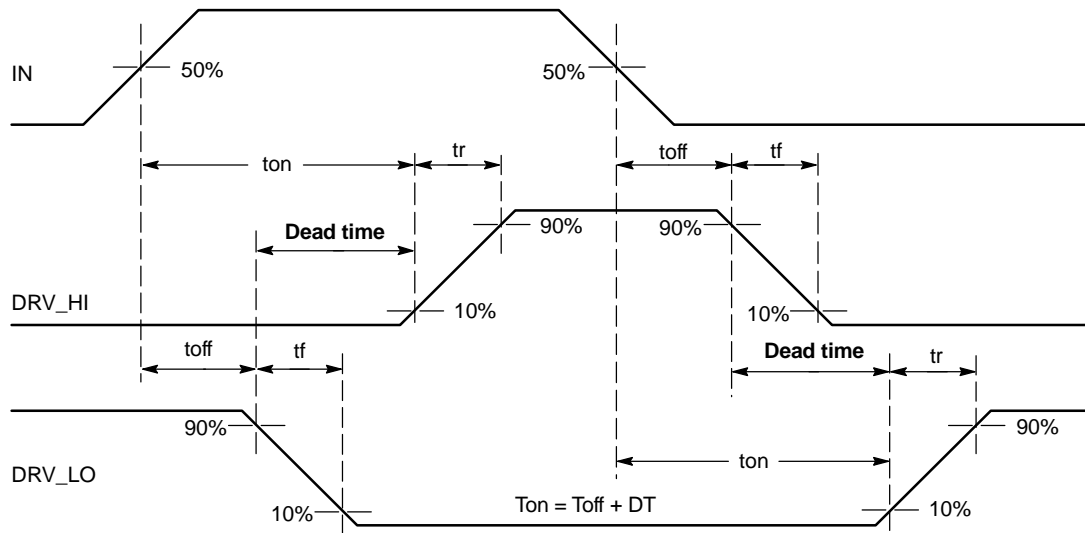
- Parameter guaranteed by design.
- $T_{ON} = T_{OFF} + DT$
- Turn-off propagation delay @  $V_{bridge} = 600\text{ V}$  is guaranteed by design.
- See characterization curve for  $\Delta t$  parameters variation on the full range temperature.
- Timing diagram definition see: Figure 4, Figure 5 and Figure 6.

# NCP5104, NCV5104



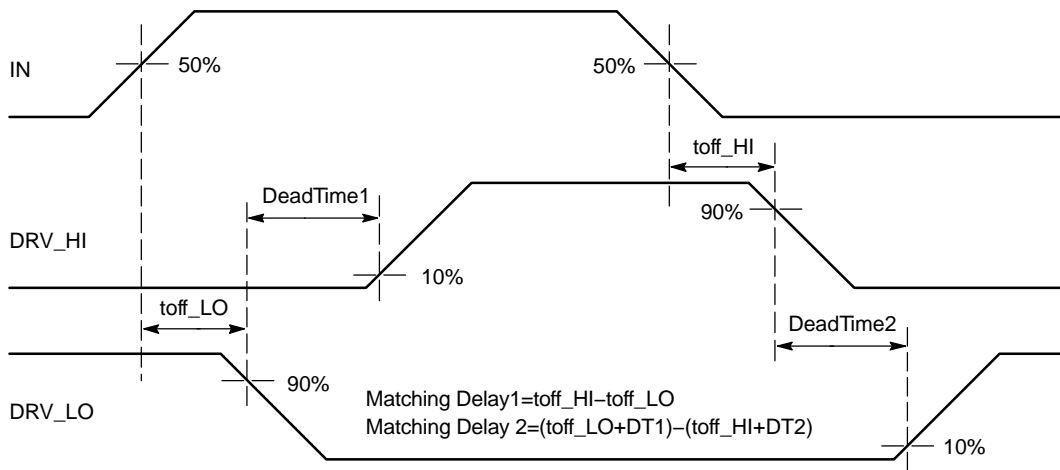
**Figure 4. Input/Output Timing Diagram**

Note: DRV\_HI output is in phase with the input

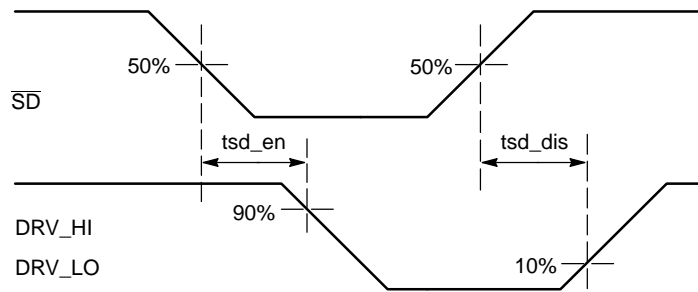


**Figure 5. Timing Definitions**

# NCP5104, NCV5104



**Figure 6. Matching Propagation Delay Definition**



**Figure 7. Shutdown Waveform Definition**

# NCP5104, NCV5104

## CHARACTERIZATION CURVES

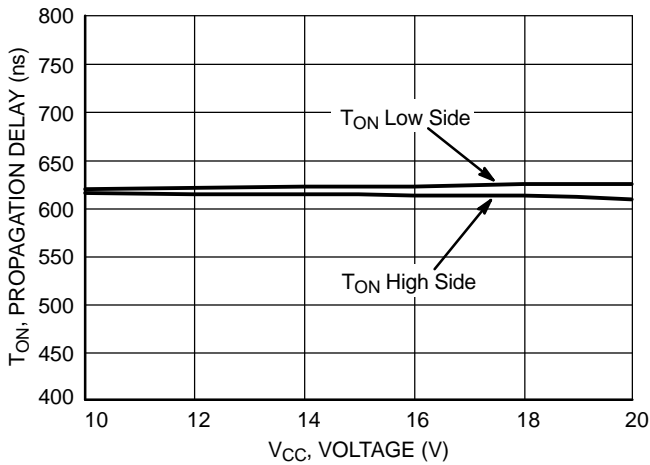


Figure 8. Turn ON Propagation Delay vs. Supply Voltage ( $V_{CC} = V_{BOOT}$ )

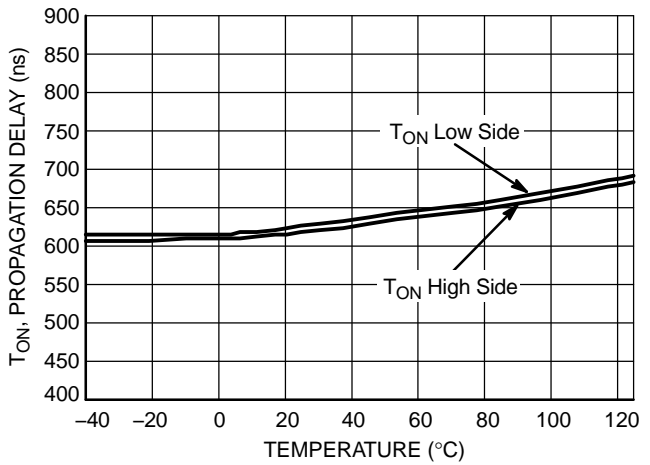


Figure 9. Turn ON Propagation Delay vs. Temperature

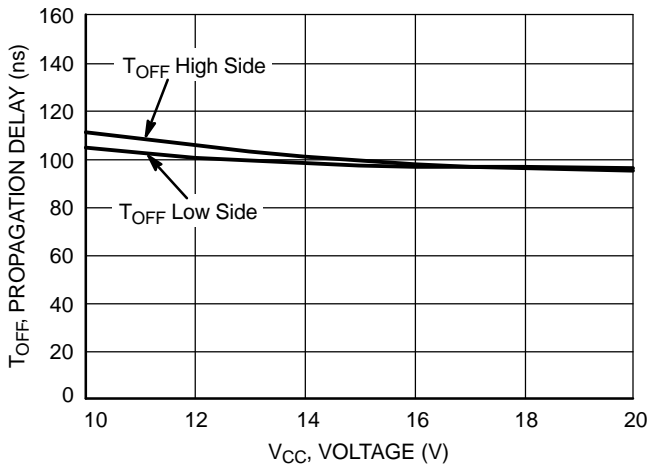


Figure 10. Turn OFF Propagation Delay vs. Supply Voltage ( $V_{CC} = V_{BOOT}$ )

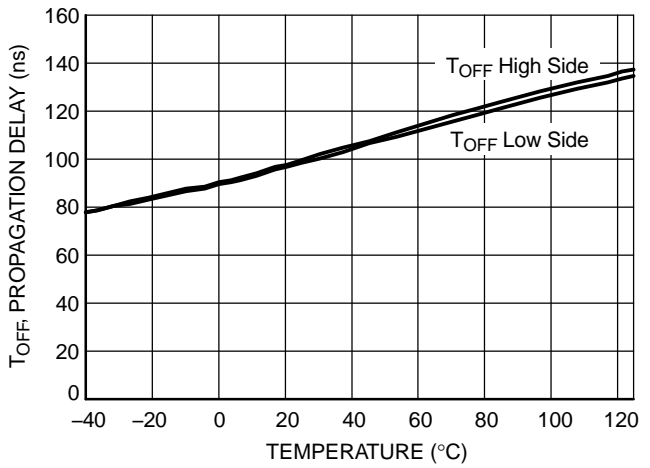


Figure 11. Turn OFF Propagation Delay vs. Temperature

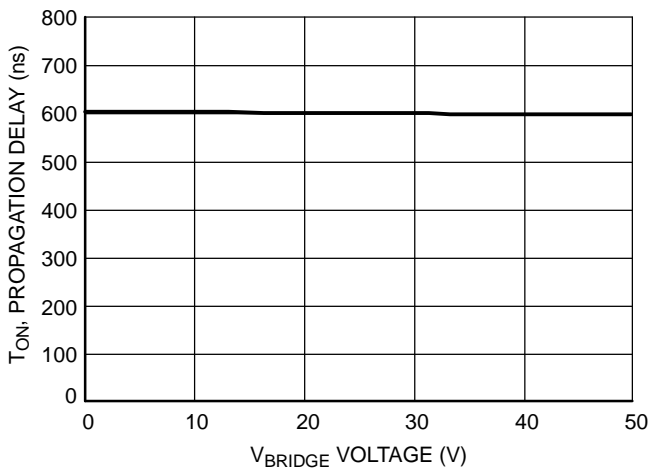


Figure 12. High Side Turn ON Propagation Delay vs.  $V_{BRIDGE}$  Voltage ( $V_{CC} = V_{BOOT}$ )

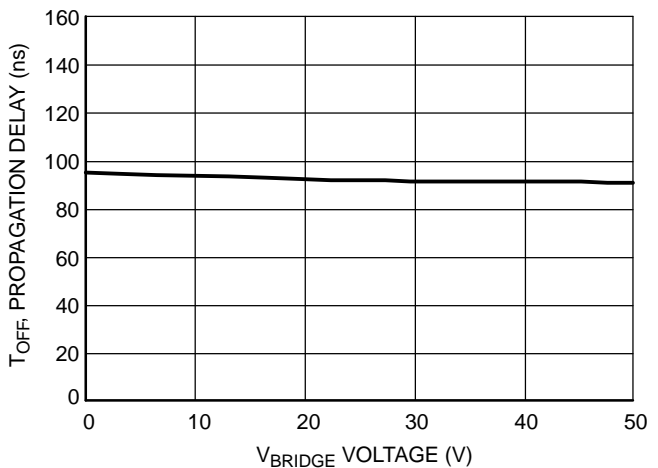
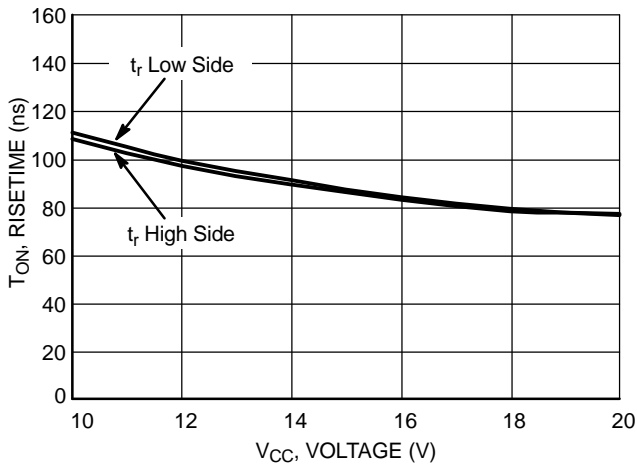


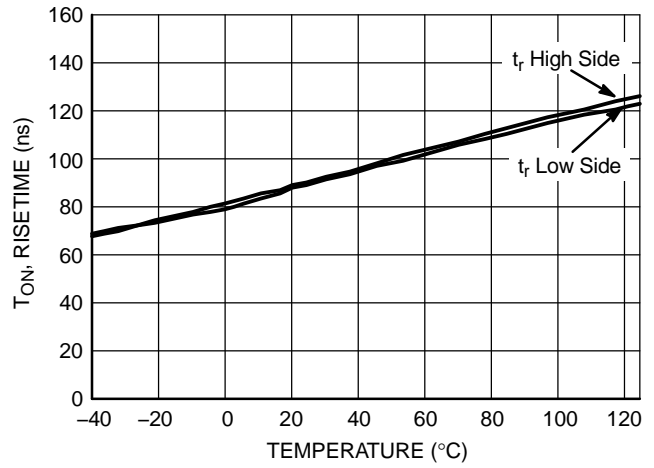
Figure 13. High Side Turn OFF Propagation Delay vs.  $V_{BRIDGE}$  Voltage ( $V_{CC} = V_{BOOT}$ )

# NCP5104, NCV5104

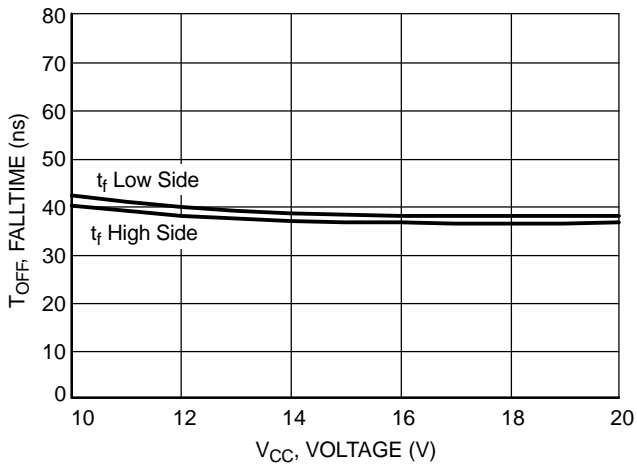
## CHARACTERIZATION CURVES



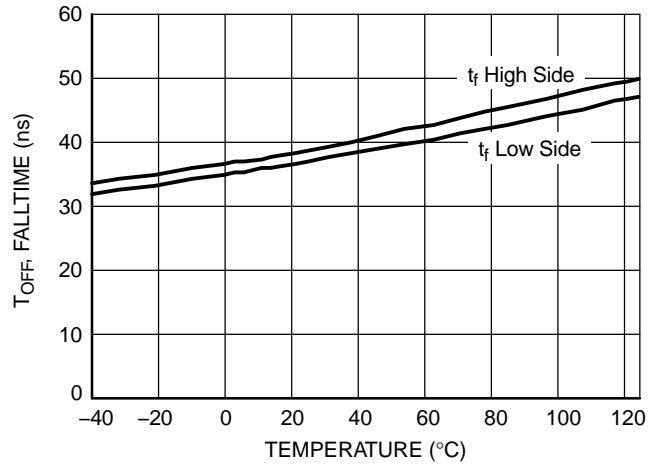
**Figure 14. Turn ON Risetime vs. Supply Voltage ( $V_{CC} = V_{BOOT}$ )**



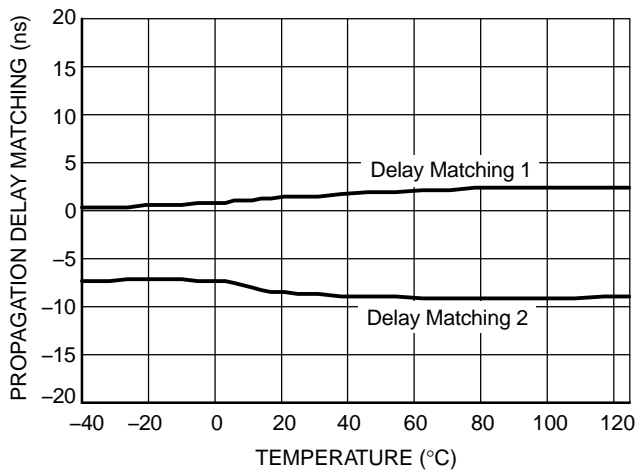
**Figure 15. Turn ON Risetime vs. Temperature**



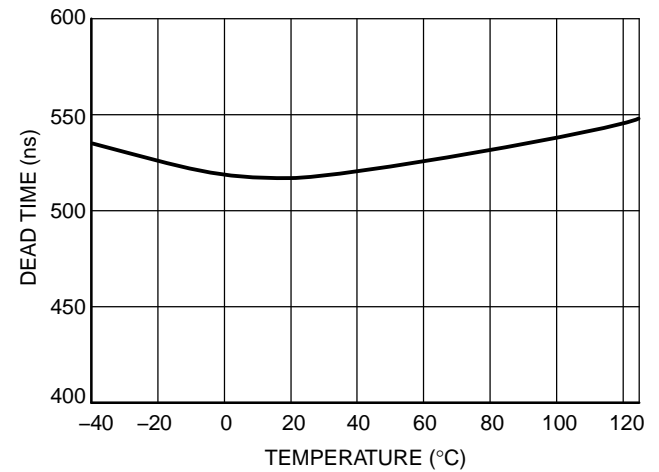
**Figure 16. Turn OFF Falltime vs. Supply Voltage ( $V_{CC} = V_{BOOT}$ )**



**Figure 17. Turn OFF Falltime vs. Temperature**



**Figure 18. Propagation Delay Matching Between High Side and Low Side Driver vs. Temperature**



**Figure 19. Dead Time vs. Temperature**



CHARACTERIZATION CURVES

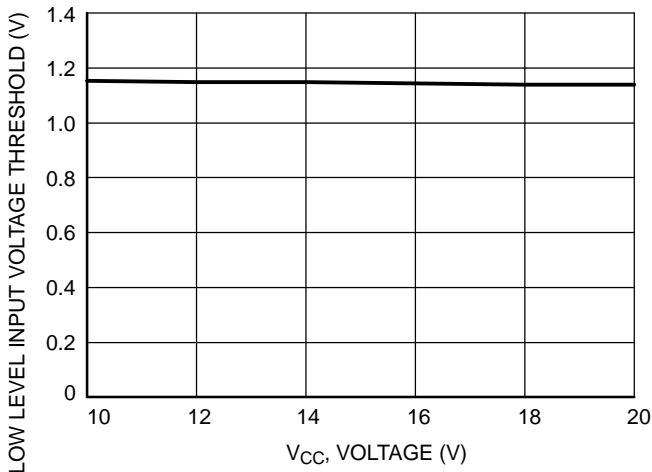


Figure 20. Low Level Input Voltage Threshold vs. Supply Voltage ( $V_{CC} = V_{BOOT}$ )

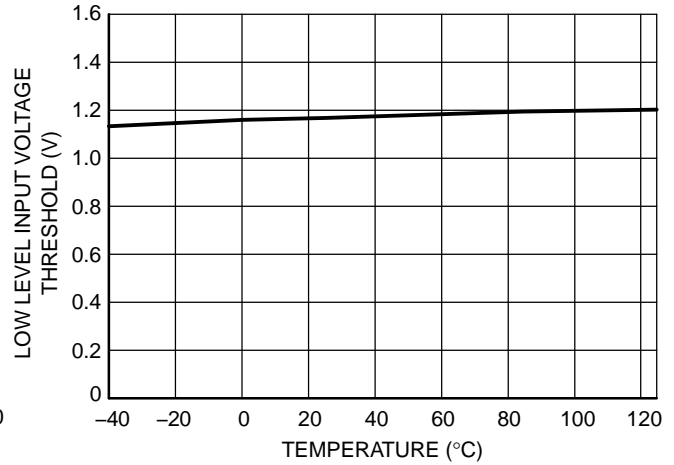


Figure 21. Low Level Input Voltage Threshold vs. Temperature

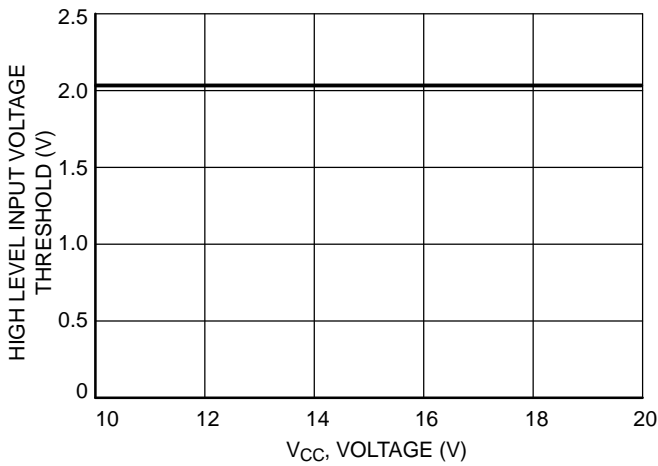


Figure 22. High Level Input Voltage Threshold vs. Supply Voltage ( $V_{CC} = V_{BOOT}$ )

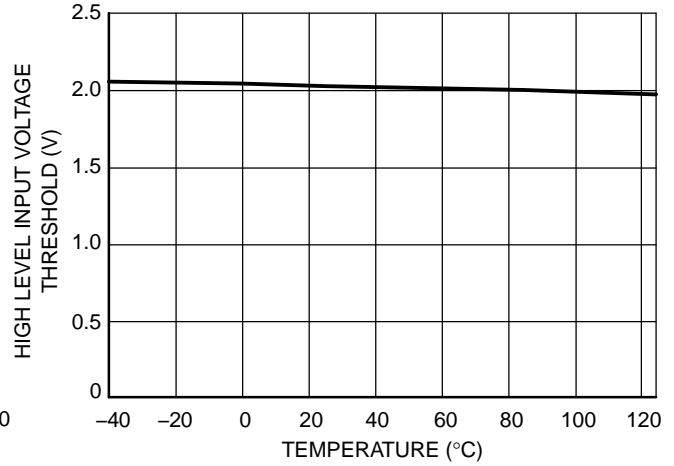


Figure 23. High Level Input Voltage Threshold vs. Temperature

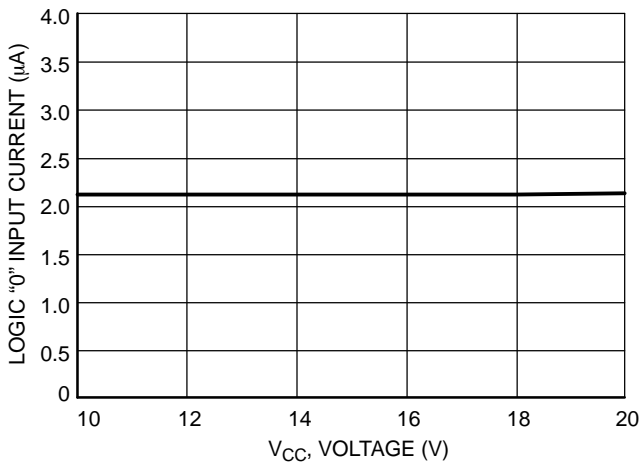


Figure 24. Logic "0" Input Current vs. Supply Voltage ( $V_{CC} = V_{BOOT}$ )

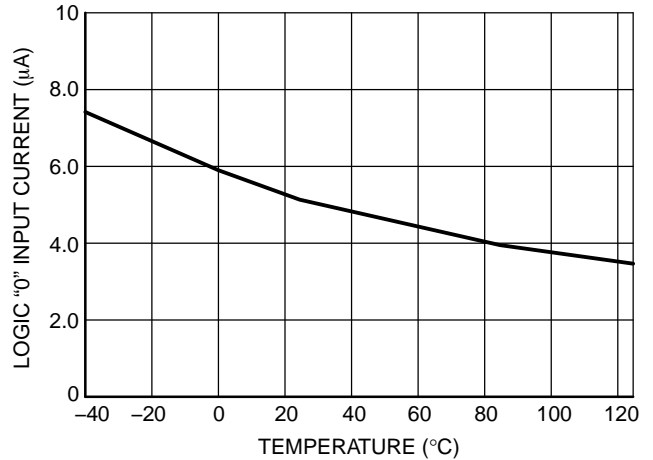


Figure 25. Logic "0" Input Current vs. Temperature

# NCP5104, NCV5104

## CHARACTERIZATION CURVES

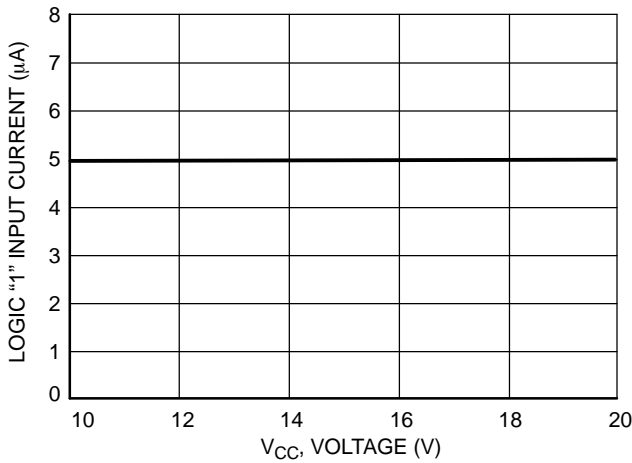


Figure 26. Logic "1" Input Current vs. Supply Voltage ( $V_{CC} = V_{BOOT}$ )

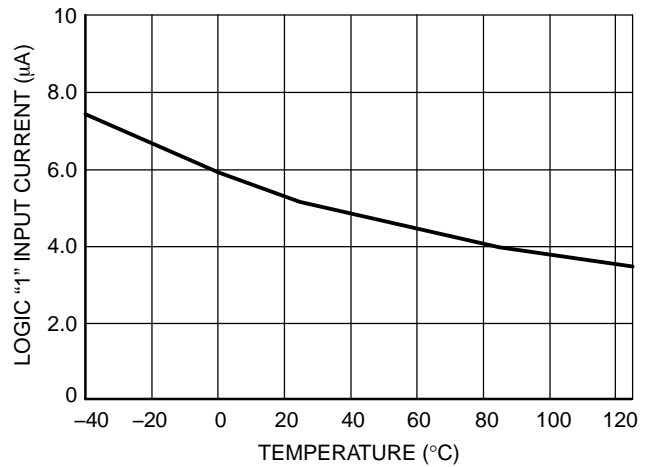


Figure 27. Logic "1" Input Current vs. Temperature

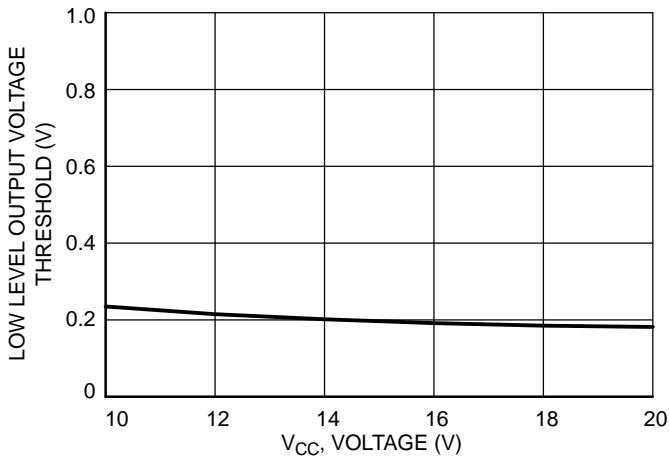


Figure 28. Low Level Output Voltage vs. Supply Voltage ( $V_{CC} = V_{BOOT}$ )

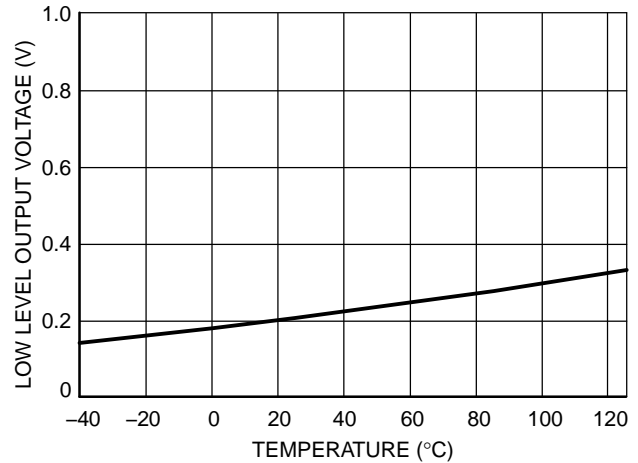


Figure 29. Low Level Output Voltage vs. Temperature

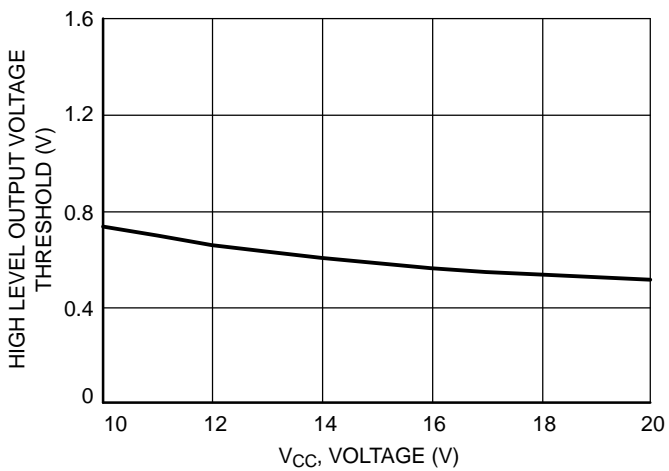


Figure 30. High Level Output Voltage vs. Supply Voltage ( $V_{CC} = V_{BOOT}$ )

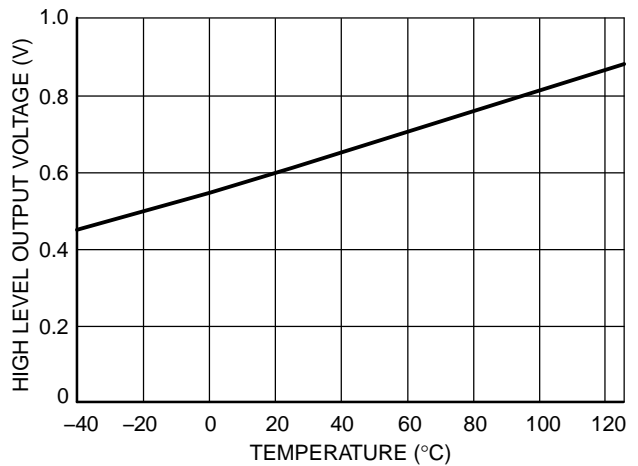


Figure 31. High Level Output Voltage vs. Temperature

# NCP5104, NCV5104

## CHARACTERIZATION CURVES

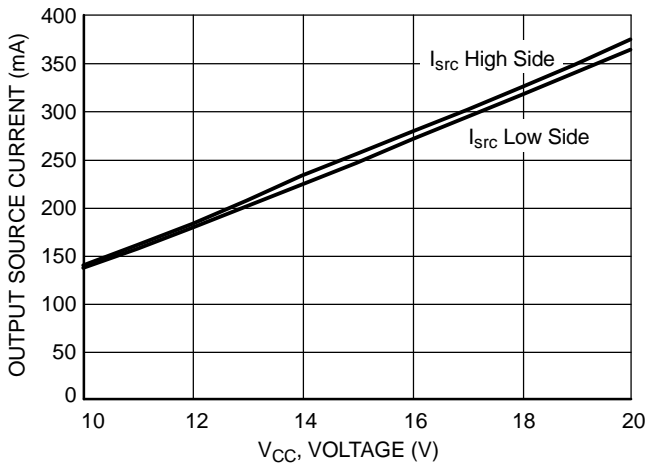


Figure 32. Output Source Current vs. Supply Voltage ( $V_{CC} = V_{BOOT}$ )

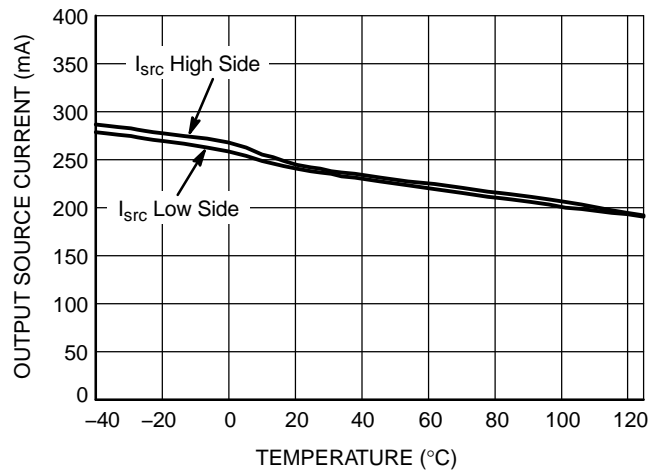


Figure 33. Output Source Current vs. Temperature

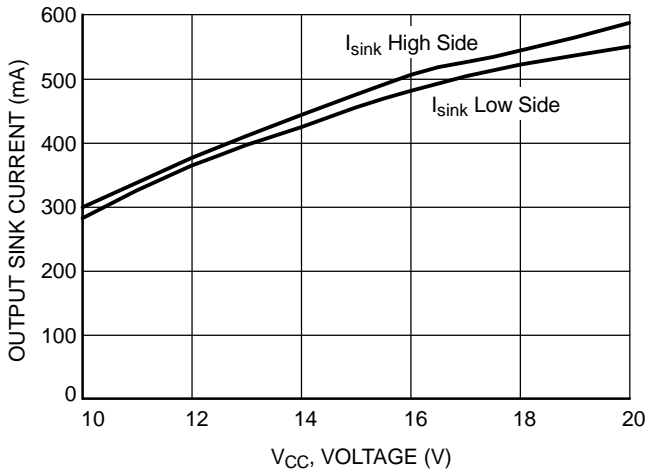


Figure 34. Output Sink Current vs. Supply Voltage ( $V_{CC} = V_{BOOT}$ )

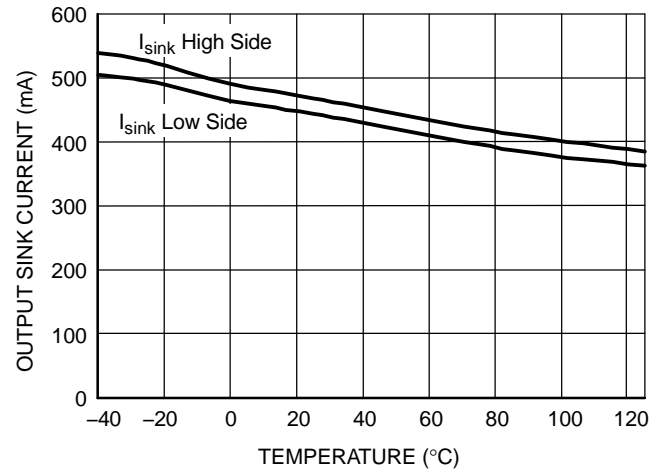


Figure 35. Output Sink Current vs. Temperature

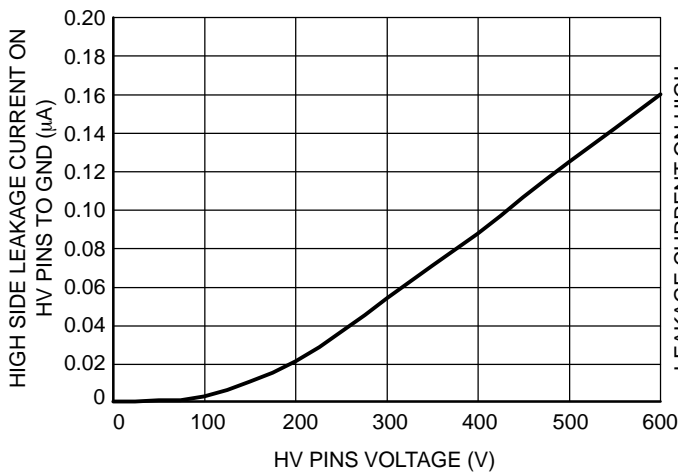


Figure 36. Leakage Current on High Voltage Pins (600 V) to Ground vs.  $V_{BRIDGE}$  Voltage ( $V_{BRIDGE} = V_{BOOT} = V_{DRV\_HI}$ )

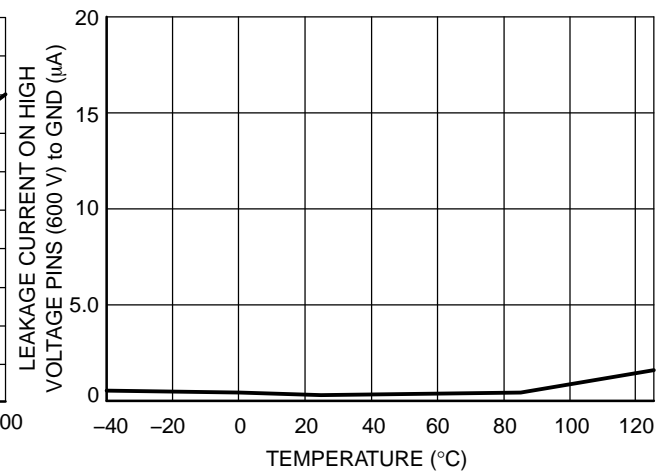


Figure 37. Leakage Current on High Voltage Pins (600 V) to Ground vs. Temperature ( $V_{BRIDGE} = V_{BOOT} = V_{DRV\_HI} = 600$  V)

# NCP5104, NCV5104

## CHARACTERIZATION CURVES

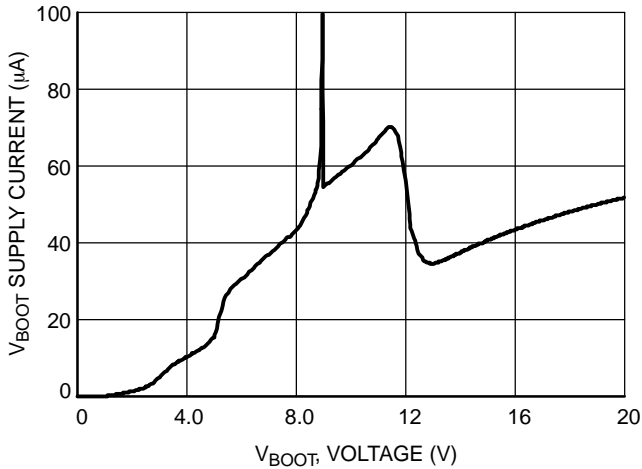


Figure 38.  $V_{BOOT}$  Supply Current vs. Bootstrap Supply Voltage ( $V_{CC} = V_{BOOT}$ )

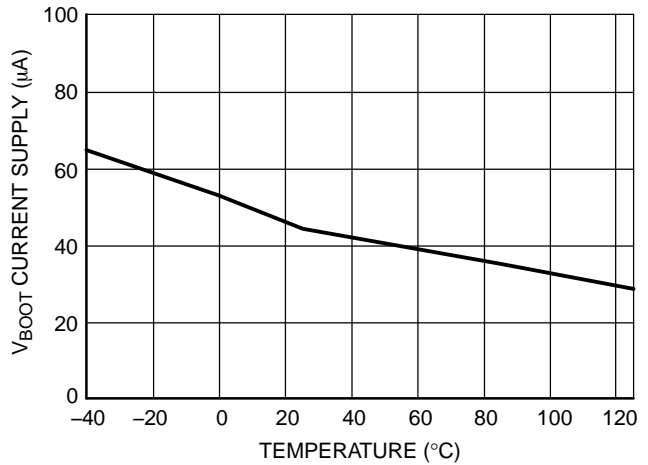


Figure 39.  $V_{BOOT}$  Supply Current vs. Temperature

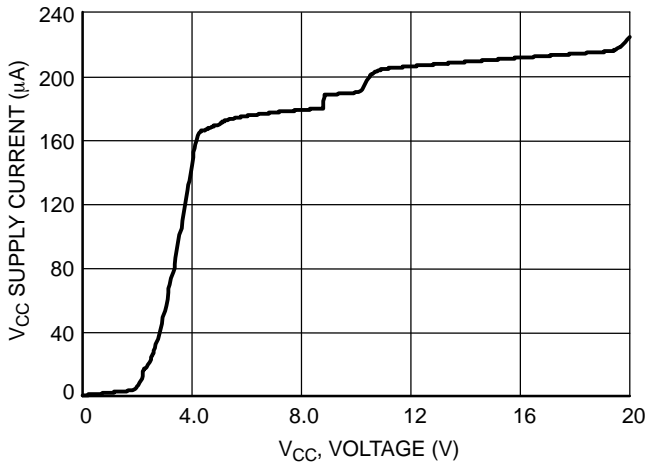


Figure 40.  $V_{CC}$  Supply Current vs.  $V_{CC}$  Supply Voltage ( $V_{CC} = V_{BOOT}$ )

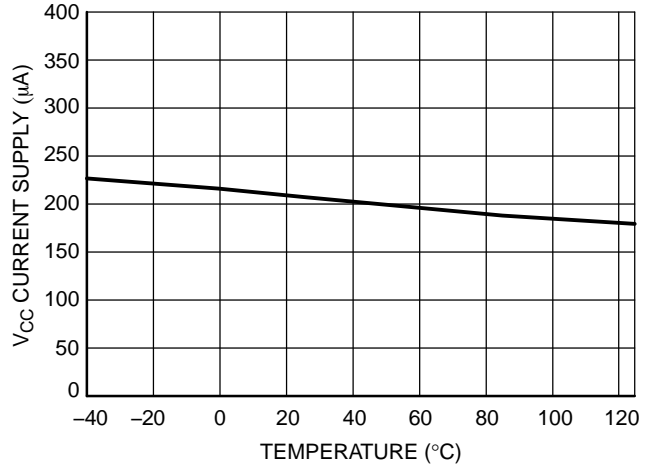


Figure 41.  $V_{CC}$  Supply Current vs. Temperature

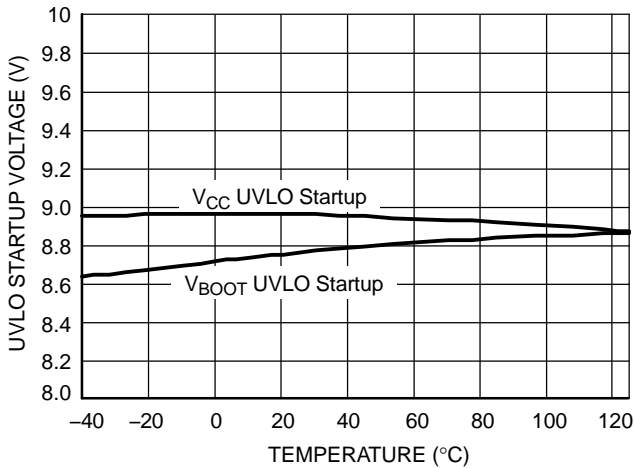


Figure 42. UVLO Startup Voltage vs. Temperature

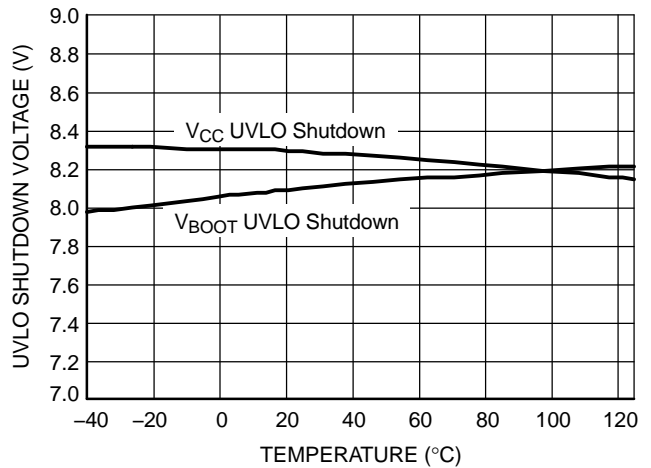


Figure 43. UVLO Shutdown Voltage vs. Temperature

CHARACTERIZATION CURVES

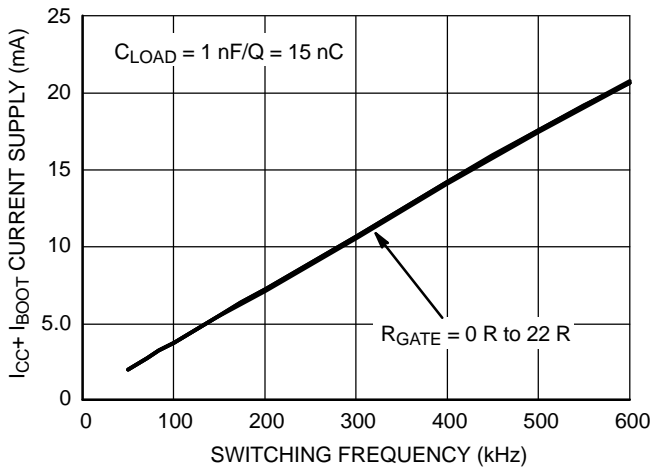


Figure 44.  $I_{CC1}$  Consumption vs. Switching Frequency with 15 nC Load on Each Driver @  $V_{CC} = 15 V$

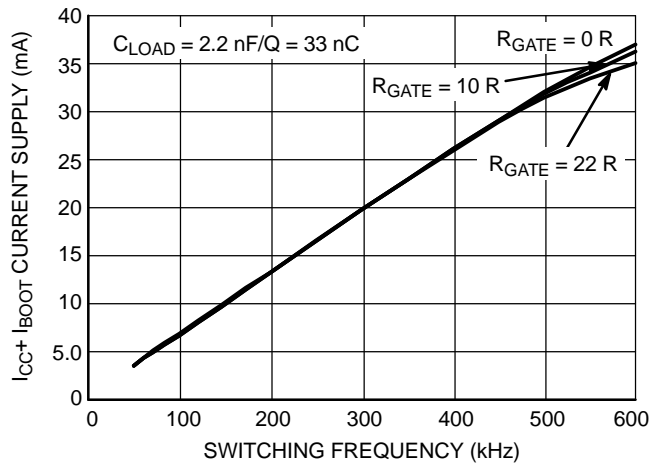


Figure 45.  $I_{CC1}$  Consumption vs. Switching Frequency with 33 nC Load on Each Driver @  $V_{CC} = 15 V$

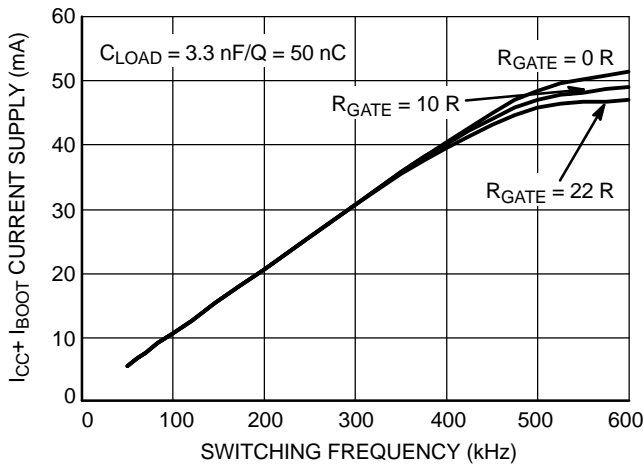


Figure 46.  $I_{CC1}$  Consumption vs. Switching Frequency with 50 nC Load on Each Driver @  $V_{CC} = 15 V$

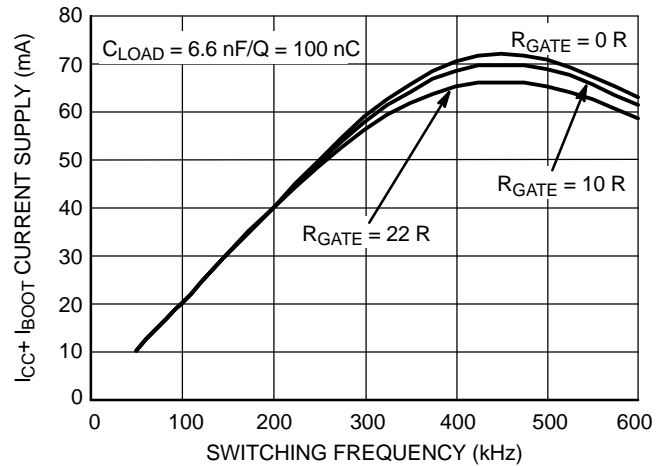


Figure 47.  $I_{CC1}$  Consumption vs. Switching Frequency with 100 nC Load on Each Driver @  $V_{CC} = 15 V$

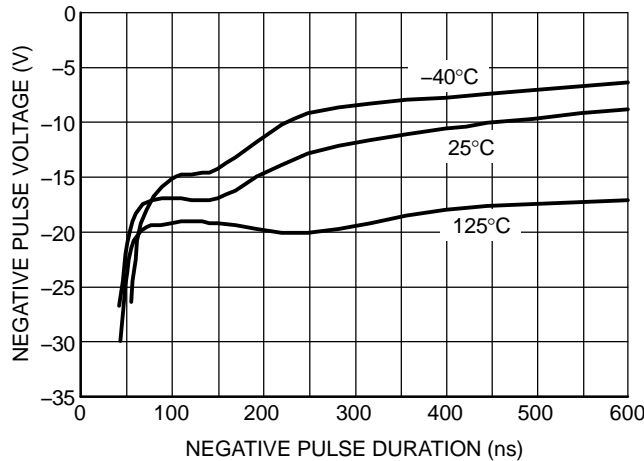


Figure 48. NCP5104, Negative Voltage Safe Operating Area on the Bridge Pin

# MECHANICAL CASE OUTLINE PACKAGE DIMENSIONS

ON Semiconductor®



SCALE 1:1

PDIP-8  
CASE 626-05  
ISSUE P

DATE 22 APR 2015



NOTES:

1. DIMENSIONING AND TOLERANCING PER ASME Y14.5M, 1994.
2. CONTROLLING DIMENSION: INCHES.
3. DIMENSIONS A, A1 AND L ARE MEASURED WITH THE PACKAGE SEATED IN JEDEC SEATING PLANE GAUGE GS-3.
4. DIMENSIONS D, D1 AND E1 DO NOT INCLUDE MOLD FLASH OR PROTRUSIONS. MOLD FLASH OR PROTRUSIONS ARE NOT TO EXCEED 0.10 INCH.
5. DIMENSION E IS MEASURED AT A POINT 0.015 BELOW DATUM PLANE H WITH THE LEADS CONSTRAINED PERPENDICULAR TO DATUM C.
6. DIMENSION eB IS MEASURED AT THE LEAD TIPS WITH THE LEADS UNCONSTRAINED.
7. DATUM PLANE H IS COINCIDENT WITH THE BOTTOM OF THE LEADS, WHERE THE LEADS EXIT THE BODY.
8. PACKAGE CONTOUR IS OPTIONAL (ROUNDED OR SQUARE CORNERS).

DIM	INCHES		MILLIMETERS	
	MIN	MAX	MIN	MAX
A	----	0.210	----	5.33
A1	0.015	----	0.38	----
A2	0.115	0.195	2.92	4.95
b	0.014	0.022	0.35	0.56
b2	0.060 TYP		1.52 TYP	
C	0.008	0.014	0.20	0.36
D	0.355	0.400	9.02	10.16
D1	0.005	----	0.13	----
E	0.300	0.325	7.62	8.26
E1	0.240	0.280	6.10	7.11
e	0.100 BSC		2.54 BSC	
eB	----	0.430	----	10.92
L	0.115	0.150	2.92	3.81
M	----	10°	----	10°

GENERIC MARKING DIAGRAM\*



- XXXX = Specific Device Code
- A = Assembly Location
- WL = Wafer Lot
- YY = Year
- WW = Work Week
- G = Pb-Free Package

\*This information is generic. Please refer to device data sheet for actual part marking. Pb-Free indicator, "G" or microdot "▪", may or may not be present.

- STYLE 1:  
PIN 1. AC IN  
2. DC + IN  
3. DC - IN  
4. AC IN  
5. GROUND  
6. OUTPUT  
7. AUXILIARY  
8. V<sub>CC</sub>

DOCUMENT NUMBER:	98ASB42420B	Electronic versions are uncontrolled except when accessed directly from the Document Repository. Printed versions are uncontrolled except when stamped "CONTROLLED COPY" in red.
DESCRIPTION:	PDIP-8	PAGE 1 OF 1

ON Semiconductor and are trademarks of Semiconductor Components Industries, LLC dba ON Semiconductor or its subsidiaries in the United States and/or other countries. ON Semiconductor reserves the right to make changes without further notice to any products herein. ON Semiconductor makes no warranty, representation or guarantee regarding the suitability of its products for any particular purpose, nor does ON Semiconductor assume any liability arising out of the application or use of any product or circuit, and specifically disclaims any and all liability, including without limitation special, consequential or incidental damages. ON Semiconductor does not convey any license under its patent rights nor the rights of others.

# MECHANICAL CASE OUTLINE PACKAGE DIMENSIONS

ON Semiconductor®



SCALE 1:1

SOIC-8 NB  
CASE 751-07  
ISSUE AK

DATE 16 FEB 2011



- NOTES:
1. DIMENSIONING AND TOLERANCING PER ANSI Y14.5M, 1982.
  2. CONTROLLING DIMENSION: MILLIMETER.
  3. DIMENSION A AND B DO NOT INCLUDE MOLD PROTRUSION.
  4. MAXIMUM MOLD PROTRUSION 0.15 (0.006) PER SIDE.
  5. DIMENSION D DOES NOT INCLUDE DAMBAR PROTRUSION. ALLOWABLE DAMBAR PROTRUSION SHALL BE 0.127 (0.005) TOTAL IN EXCESS OF THE D DIMENSION AT MAXIMUM MATERIAL CONDITION.
  6. 751-01 THRU 751-06 ARE OBSOLETE. NEW STANDARD IS 751-07.

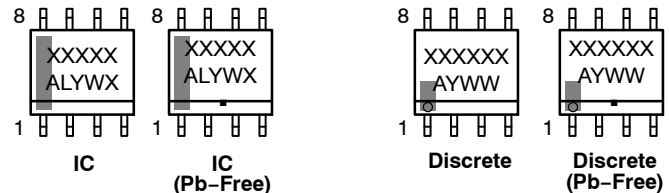
DIM	MILLIMETERS		INCHES	
	MIN	MAX	MIN	MAX
A	4.80	5.00	0.189	0.197
B	3.80	4.00	0.150	0.157
C	1.35	1.75	0.053	0.069
D	0.33	0.51	0.013	0.020
G	1.27 BSC		0.050 BSC	
H	0.10	0.25	0.004	0.010
J	0.19	0.25	0.007	0.010
K	0.40	1.27	0.016	0.050
M	0°	8°	0°	8°
N	0.25	0.50	0.010	0.020
S	5.80	6.20	0.228	0.244

### SOLDERING FOOTPRINT\*



\*For additional information on our Pb-Free strategy and soldering details, please download the ON Semiconductor Soldering and Mounting Techniques Reference Manual, SOLDERRM/D.

### GENERIC MARKING DIAGRAM\*



XXXXXX = Specific Device Code  
 A = Assembly Location  
 L = Wafer Lot  
 Y = Year  
 W = Work Week  
 ■ = Pb-Free Package

XXXXXX = Specific Device Code  
 A = Assembly Location  
 Y = Year  
 WW = Work Week  
 ■ = Pb-Free Package

\*This information is generic. Please refer to device data sheet for actual part marking. Pb-Free indicator, "G" or microdot "•", may or may not be present. Some products may not follow the Generic Marking.

STYLES ON PAGE 2

DOCUMENT NUMBER:	98ASB42564B	Electronic versions are uncontrolled except when accessed directly from the Document Repository. Printed versions are uncontrolled except when stamped "CONTROLLED COPY" in red.
DESCRIPTION:	SOIC-8 NB	PAGE 1 OF 2

ON Semiconductor and ON are trademarks of Semiconductor Components Industries, LLC dba ON Semiconductor or its subsidiaries in the United States and/or other countries. ON Semiconductor reserves the right to make changes without further notice to any products herein. ON Semiconductor makes no warranty, representation or guarantee regarding the suitability of its products for any particular purpose, nor does ON Semiconductor assume any liability arising out of the application or use of any product or circuit, and specifically disclaims any and all liability, including without limitation special, consequential or incidental damages. ON Semiconductor does not convey any license under its patent rights nor the rights of others.

**SOIC-8 NB**  
**CASE 751-07**  
**ISSUE AK**

DATE 16 FEB 2011

- |  |   |   |   |
|--|---|---|---|
| <p><b>STYLE 1:</b><br/>         PIN 1. EMITTER<br/>         2. COLLECTOR<br/>         3. COLLECTOR<br/>         4. EMITTER<br/>         5. EMITTER<br/>         6. BASE<br/>         7. BASE<br/>         8. EMITTER</p>   | <p><b>STYLE 2:</b><br/>         PIN 1. COLLECTOR, DIE, #1<br/>         2. COLLECTOR, #1<br/>         3. COLLECTOR, #2<br/>         4. COLLECTOR, #2<br/>         5. BASE, #2<br/>         6. EMITTER, #2<br/>         7. BASE, #1<br/>         8. EMITTER, #1</p>               | <p><b>STYLE 3:</b><br/>         PIN 1. DRAIN, DIE #1<br/>         2. DRAIN, #1<br/>         3. DRAIN, #2<br/>         4. DRAIN, #2<br/>         5. GATE, #2<br/>         6. SOURCE, #2<br/>         7. GATE, #1<br/>         8. SOURCE, #1</p>                            | <p><b>STYLE 4:</b><br/>         PIN 1. ANODE<br/>         2. ANODE<br/>         3. ANODE<br/>         4. ANODE<br/>         5. ANODE<br/>         6. ANODE<br/>         7. ANODE<br/>         8. COMMON CATHODE</p>   |
| <p><b>STYLE 5:</b><br/>         PIN 1. DRAIN<br/>         2. DRAIN<br/>         3. DRAIN<br/>         4. DRAIN<br/>         5. GATE<br/>         6. GATE<br/>         7. SOURCE<br/>         8. SOURCE</p>   | <p><b>STYLE 6:</b><br/>         PIN 1. SOURCE<br/>         2. DRAIN<br/>         3. DRAIN<br/>         4. SOURCE<br/>         5. SOURCE<br/>         6. GATE<br/>         7. GATE<br/>         8. SOURCE</p>  | <p><b>STYLE 7:</b><br/>         PIN 1. INPUT<br/>         2. EXTERNAL BYPASS<br/>         3. THIRD STAGE SOURCE<br/>         4. GROUND<br/>         5. DRAIN<br/>         6. GATE 3<br/>         7. SECOND STAGE Vd<br/>         8. FIRST STAGE Vd</p>                    | <p><b>STYLE 8:</b><br/>         PIN 1. COLLECTOR, DIE #1<br/>         2. BASE, #1<br/>         3. BASE, #2<br/>         4. COLLECTOR, #2<br/>         5. COLLECTOR, #2<br/>         6. EMITTER, #2<br/>         7. EMITTER, #1<br/>         8. COLLECTOR, #1</p>                              |
| <p><b>STYLE 9:</b><br/>         PIN 1. EMITTER, COMMON<br/>         2. COLLECTOR, DIE #1<br/>         3. COLLECTOR, DIE #2<br/>         4. EMITTER, COMMON<br/>         5. EMITTER, COMMON<br/>         6. BASE, DIE #2<br/>         7. BASE, DIE #1<br/>         8. EMITTER, COMMON</p> | <p><b>STYLE 10:</b><br/>         PIN 1. GROUND<br/>         2. BIAS 1<br/>         3. OUTPUT<br/>         4. GROUND<br/>         5. GROUND<br/>         6. BIAS 2<br/>         7. INPUT<br/>         8. GROUND</p>  | <p><b>STYLE 11:</b><br/>         PIN 1. SOURCE 1<br/>         2. GATE 1<br/>         3. SOURCE 2<br/>         4. GATE 2<br/>         5. DRAIN 2<br/>         6. DRAIN 2<br/>         7. DRAIN 1<br/>         8. DRAIN 1</p>   | <p><b>STYLE 12:</b><br/>         PIN 1. SOURCE<br/>         2. SOURCE<br/>         3. SOURCE<br/>         4. GATE<br/>         5. DRAIN<br/>         6. DRAIN<br/>         7. DRAIN<br/>         8. DRAIN</p>   |
| <p><b>STYLE 13:</b><br/>         PIN 1. N.C.<br/>         2. SOURCE<br/>         3. SOURCE<br/>         4. GATE<br/>         5. DRAIN<br/>         6. DRAIN<br/>         7. DRAIN<br/>         8. DRAIN</p>  | <p><b>STYLE 14:</b><br/>         PIN 1. N-SOURCE<br/>         2. N-GATE<br/>         3. P-SOURCE<br/>         4. P-GATE<br/>         5. P-DRAIN<br/>         6. P-DRAIN<br/>         7. N-DRAIN<br/>         8. N-DRAIN</p>   | <p><b>STYLE 15:</b><br/>         PIN 1. ANODE 1<br/>         2. ANODE 1<br/>         3. ANODE 1<br/>         4. ANODE 1<br/>         5. CATHODE, COMMON<br/>         6. CATHODE, COMMON<br/>         7. CATHODE, COMMON<br/>         8. CATHODE, COMMON</p>               | <p><b>STYLE 16:</b><br/>         PIN 1. EMITTER, DIE #1<br/>         2. BASE, DIE #1<br/>         3. EMITTER, DIE #2<br/>         4. BASE, DIE #2<br/>         5. COLLECTOR, DIE #2<br/>         6. COLLECTOR, DIE #2<br/>         7. COLLECTOR, DIE #1<br/>         8. COLLECTOR, DIE #1</p> |
| <p><b>STYLE 17:</b><br/>         PIN 1. VCC<br/>         2. V2OUT<br/>         3. V1OUT<br/>         4. TXE<br/>         5. RXE<br/>         6. VEE<br/>         7. GND<br/>         8. ACC</p>  | <p><b>STYLE 18:</b><br/>         PIN 1. ANODE<br/>         2. ANODE<br/>         3. SOURCE<br/>         4. GATE<br/>         5. DRAIN<br/>         6. DRAIN<br/>         7. CATHODE<br/>         8. CATHODE</p>   | <p><b>STYLE 19:</b><br/>         PIN 1. SOURCE 1<br/>         2. GATE 1<br/>         3. SOURCE 2<br/>         4. GATE 2<br/>         5. DRAIN 2<br/>         6. MIRROR 2<br/>         7. DRAIN 1<br/>         8. MIRROR 1</p>   | <p><b>STYLE 20:</b><br/>         PIN 1. SOURCE (N)<br/>         2. GATE (N)<br/>         3. SOURCE (P)<br/>         4. GATE (P)<br/>         5. DRAIN<br/>         6. DRAIN<br/>         7. DRAIN<br/>         8. DRAIN</p>   |
| <p><b>STYLE 21:</b><br/>         PIN 1. CATHODE 1<br/>         2. CATHODE 2<br/>         3. CATHODE 3<br/>         4. CATHODE 4<br/>         5. CATHODE 5<br/>         6. COMMON ANODE<br/>         7. COMMON ANODE<br/>         8. CATHODE 6</p>  | <p><b>STYLE 22:</b><br/>         PIN 1. I/O LINE 1<br/>         2. COMMON CATHODE/VCC<br/>         3. COMMON CATHODE/VCC<br/>         4. I/O LINE 3<br/>         5. COMMON ANODE/GND<br/>         6. I/O LINE 4<br/>         7. I/O LINE 5<br/>         8. COMMON ANODE/GND</p> | <p><b>STYLE 23:</b><br/>         PIN 1. LINE 1 IN<br/>         2. COMMON ANODE/GND<br/>         3. COMMON ANODE/GND<br/>         4. LINE 2 IN<br/>         5. LINE 2 OUT<br/>         6. COMMON ANODE/GND<br/>         7. COMMON ANODE/GND<br/>         8. LINE 1 OUT</p> | <p><b>STYLE 24:</b><br/>         PIN 1. BASE<br/>         2. EMITTER<br/>         3. COLLECTOR/ANODE<br/>         4. COLLECTOR/ANODE<br/>         5. CATHODE<br/>         6. CATHODE<br/>         7. COLLECTOR/ANODE<br/>         8. COLLECTOR/ANODE</p>                                      |
| <p><b>STYLE 25:</b><br/>         PIN 1. VIN<br/>         2. N/C<br/>         3. REXT<br/>         4. GND<br/>         5. IOUT<br/>         6. IOUT<br/>         7. IOUT<br/>         8. IOUT</p>   | <p><b>STYLE 26:</b><br/>         PIN 1. GND<br/>         2. dv/dt<br/>         3. ENABLE<br/>         4. ILIMIT<br/>         5. SOURCE<br/>         6. SOURCE<br/>         7. SOURCE<br/>         8. VCC</p>  | <p><b>STYLE 27:</b><br/>         PIN 1. ILIMIT<br/>         2. OVLO<br/>         3. UVLO<br/>         4. INPUT+<br/>         5. SOURCE<br/>         6. SOURCE<br/>         7. SOURCE<br/>         8. DRAIN</p>  | <p><b>STYLE 28:</b><br/>         PIN 1. SW_TO_GND<br/>         2. DASIC OFF<br/>         3. DASIC_SW_DET<br/>         4. GND<br/>         5. V_MON<br/>         6. VBULK<br/>         7. VBULK<br/>         8. VIN</p>  |
| <p><b>STYLE 29:</b><br/>         PIN 1. BASE, DIE #1<br/>         2. EMITTER, #1<br/>         3. BASE, #2<br/>         4. EMITTER, #2<br/>         5. COLLECTOR, #2<br/>         6. COLLECTOR, #2<br/>         7. COLLECTOR, #1<br/>         8. COLLECTOR, #1</p>                        | <p><b>STYLE 30:</b><br/>         PIN 1. DRAIN 1<br/>         2. DRAIN 1<br/>         3. GATE 2<br/>         4. SOURCE 2<br/>         5. SOURCE 1/DRAIN 2<br/>         6. SOURCE 1/DRAIN 2<br/>         7. SOURCE 1/DRAIN 2<br/>         8. GATE 1</p>                           |   |   |

<b>DOCUMENT NUMBER:</b>	<b>98ASB42564B</b>	Electronic versions are uncontrolled except when accessed directly from the Document Repository. Printed versions are uncontrolled except when stamped "CONTROLLED COPY" in red.
<b>DESCRIPTION:</b>	<b>SOIC-8 NB</b>	<b>PAGE 2 OF 2</b>

ON Semiconductor and  are trademarks of Semiconductor Components Industries, LLC dba ON Semiconductor or its subsidiaries in the United States and/or other countries. ON Semiconductor reserves the right to make changes without further notice to any products herein. ON Semiconductor makes no warranty, representation or guarantee regarding the suitability of its products for any particular purpose, nor does ON Semiconductor assume any liability arising out of the application or use of any product or circuit, and specifically disclaims any and all liability, including without limitation special, consequential or incidental damages. ON Semiconductor does not convey any license under its patent rights nor the rights of others.



**onsemi**, **Onsemi**, and other names, marks, and brands are registered and/or common law trademarks of Semiconductor Components Industries, LLC dba "**onsemi**" or its affiliates and/or subsidiaries in the United States and/or other countries. **onsemi** owns the rights to a number of patents, trademarks, copyrights, trade secrets, and other intellectual property. A listing of **onsemi**'s product/patent coverage may be accessed at [www.onsemi.com/site/pdf/Patent-Marking.pdf](http://www.onsemi.com/site/pdf/Patent-Marking.pdf). **onsemi** reserves the right to make changes at any time to any products or information herein, without notice. The information herein is provided "as-is" and **onsemi** makes no warranty, representation or guarantee regarding the accuracy of the information, product features, availability, functionality, or suitability of its products for any particular purpose, nor does **onsemi** assume any liability arising out of the application or use of any product or circuit, and specifically disclaims any and all liability, including without limitation special, consequential or incidental damages. Buyer is responsible for its products and applications using **onsemi** products, including compliance with all laws, regulations and safety requirements or standards, regardless of any support or applications information provided by **onsemi**. "Typical" parameters which may be provided in **onsemi** data sheets and/or specifications can and do vary in different applications and actual performance may vary over time. All operating parameters, including "Typicals" must be validated for each customer application by customer's technical experts. **onsemi** does not convey any license under any of its intellectual property rights nor the rights of others. **onsemi** products are not designed, intended, or authorized for use as a critical component in life support systems or any FDA Class 3 medical devices or medical devices with a same or similar classification in a foreign jurisdiction or any devices intended for implantation in the human body. Should Buyer purchase or use **onsemi** products for any such unintended or unauthorized application, Buyer shall indemnify and hold **onsemi** and its officers, employees, subsidiaries, affiliates, and distributors harmless against all claims, costs, damages, and expenses, and reasonable attorney fees arising out of, directly or indirectly, any claim of personal injury or death associated with such unintended or unauthorized use, even if such claim alleges that **onsemi** was negligent regarding the design or manufacture of the part. **onsemi** is an Equal Opportunity/Affirmative Action Employer. This literature is subject to all applicable copyright laws and is not for resale in any manner.

## PUBLICATION ORDERING INFORMATION

### LITERATURE FULFILLMENT:

Email Requests to: [orderlit@onsemi.com](mailto:orderlit@onsemi.com)

**onsemi Website:** [www.onsemi.com](http://www.onsemi.com)

### TECHNICAL SUPPORT

**North American Technical Support:**

Voice Mail: 1 800-282-9855 Toll Free USA/Canada

Phone: 011 421 33 790 2910

**Europe, Middle East and Africa Technical Support:**

Phone: 00421 33 790 2910

For additional information, please contact your local Sales Representative

# Mouser Electronics

Authorized Distributor

Click to View Pricing, Inventory, Delivery & Lifecycle Information:

[onsemi:](#)

[NCP5104DR2G](#) [NCP5104PG](#) [NCV5104DR2G](#)